

## FEATURES

- Ultra Low Dropout Voltage
- Low Ground Pin Current
- Excellent Line and Load Regulation
- Guaranteed Output Current of 1A
- Available in SOT-23-5, SOT-223, TO-252, and SOP-8 Packages
- Fixed Output Voltages : 1.2V, 1.5V, 1.8V, 2.5V, and 3.3V
- SENSE Option Improves Load Regulation
- Over-Temperature/Over-Current Protection
- -40°C to 125°C Junction Temperature Range
- Moisture Sensitivity Level 3

## APPLICATION

- Battery Powered Equipments
- Motherboards and Graphic Cards
- Microprocessor Power Supplies
- Peripheral Cards
- High Efficiency Linear Regulators
- Battery Chargers

## DESCRIPTION

The TJ3964 series of high performance ultra low-dropout linear regulators operates from 2.5V to 6V input supply and provides ultra low-dropout voltage, high output current with low ground current. Wide range of preset output voltage options are available.

These ultra low dropout linear regulators respond fast to step changes in load which makes them suitable for low voltage micro-processor applications. The TJ3964 is developed on a CMOS process technology which allows low quiescent current operation independent of output load current. This CMOS process also allows the TJ3964 to operate under extremely low dropout conditions.

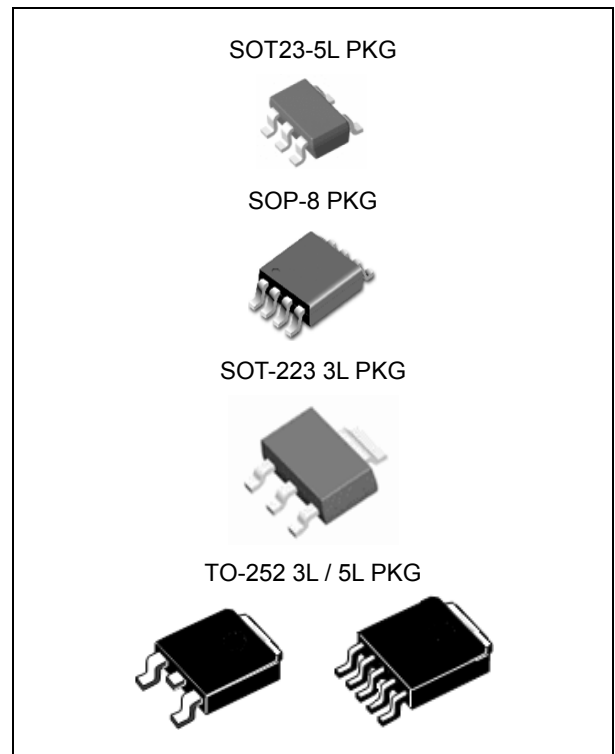

## ORDERING INFORMATION

Device	Package
TJ3964SF5-ADJ	SOT-23 5L
TJ3964SF5-X.X	
TJ3964GSF5-ADJ	
TJ3964GSF5-X.X	
TJ3964D-ADJ	SOP-8
TJ3964D-X.X	
TJ3964S-X.X	SOT-223 3L
TJ3964GRS-ADJ	TO-252 3L / 5L
TJ3964GRS-X.X	

X.X = Output Voltage = 1.2, 1.5, 1.8, 2.5, and 3.3

## Absolute Maximum Ratings

CHARACTERISTIC	SYMBOL	MIN.	MAX.	UNIT
Input Supply Voltage (Survival)	$V_{IN}$	-0.3	6.5	V
Enable Input Voltage (Survival)	$V_{EN}^{(1)}$	-0.3	6.5	V
Maximum Output Current	$I_{MAX}$	-	1.0	A
Lead Temperature (Soldering, 5 sec)	$T_{SOL}$		260	°C
Storage Temperature Range	$T_{STG}$	-65	150	°C
Operating Junction Temperature Range	$T_{JOPR}$	-40	125	°C

(1) It is recommended for  $V_{EN}$  voltage not to exceed  $V_{IN}$  voltage.

# 1A Ultra Low Dropout Linear Regulator

# TJ3964

## Ordering Information

V <sub>OUT</sub>	Package	Order No.	Description	Supplied As	Status
ADJ	SOT-23 5L	TJ3964SF5 -ADJ	1A, Adjustable, Enable	Reel	Contact us
	SOT-23 5L	TJ3964GSF5 -ADJ	1A, Adjustable, Enable	Reel	Contact us
	TO-252 5L	TJ3964GRS -ADJ -5L	1A, Adjustable, Enable	Reel	Contact us
	SOP-8 8L	TJ3964D -ADJ	1A, Adjustable, Enable	Reel	Contact us
1.2V	SOT-23 5L	TJ3964SF5 -1.2	1A, Enable, Sense	Reel	Contact us
	SOT-23 5L	TJ3964GSF5 -1.2	1A, Enable, Sense	Reel	Contact us
	SOT-223 3L	TJ3964S -1.2	1A	Reel	Contact us
	TO-252 3L	TJ3964GRS -1.2 -3L	1A	Reel	Contact us
	TO-252 5L	TJ3964GRS -1.2 -5L	1A, Enable, Sense	Reel	Contact us
	SOP-8 8L	TJ3964D -1.2	1A, Enable, Sense	Reel	Contact us
1.5V	SOT-23 5L	TJ3964SF5 -1.5	1A, Enable, Sense	Reel	Contact us
	SOT-23 5L	TJ3964GSF5 -1.5	1A, Enable, Sense	Reel	Contact us
	SOT-223 3L	TJ3964S -1.5	1A	Reel	Contact us
	TO-252 3L	TJ3964GRS -1.5 -3L	1A	Reel	Contact us
	TO-252 5L	TJ3964GRS -1.5 -5L	1A, Enable, Sense	Reel	Contact us
	SOP-8 8L	TJ3964D -1.5	1A, Enable, Sense	Reel	Contact us
1.8V	SOT-23 5L	TJ3964SF5 -1.8	1A, Enable, Sense	Reel	Contact us
	SOT-23 5L	TJ3964GSF5 -1.8	1A, Enable, Sense	Reel	Contact us
	SOT-223 3L	TJ3964S -1.8	1A	Reel	Contact us
	TO-252 3L	TJ3964GRS -1.8 -3L	1A	Reel	Contact us
	TO-252 5L	TJ3964GRS -1.8 -5L	1A, Enable, Sense	Reel	Contact us
	SOP-8 8L	TJ3964D -1.8	1A, Enable, Sense	Reel	Contact us
2.5V	SOT-23 5L	TJ3964SF5 -2.5	1A, Enable, Sense	Reel	Contact us
	SOT-23 5L	TJ3964GSF5 -2.5	1A, Enable, Sense	Reel	Contact us
	SOT-223 3L	TJ3964S -2.5	1A	Reel	Contact us
	TO-252 3L	TJ3964GRS -2.5 -3L	1A	Reel	Contact us
	TO-252 5L	TJ3964GRS -2.5 -5L	1A, Enable, Sense	Reel	Contact us
	SOP-8 8L	TJ3964D -2.5	1A, Enable, Sense	Reel	Contact us
3.3V	SOT-23 5L	TJ3964SF5 -3.3	1A, Enable, Sense	Reel	Contact us
	SOT-23 5L	TJ3964GSF5 -3.3	1A, Enable, Sense	Reel	Contact us
	SOT-223 3L	TJ3964S -3.3	1A	Reel	Contact us
	TO-252 3L	TJ3964GRS -3.3 -3L	1A	Reel	Contact us
	TO-252 5L	TJ3964GRS -3.3 -5L	1A, Enable, Sense	Reel	Contact us
	SOP-8 8L	TJ3964D -3.3	1A, Enable, Sense	Reel	Contact us

## Ordering Information (Continued)

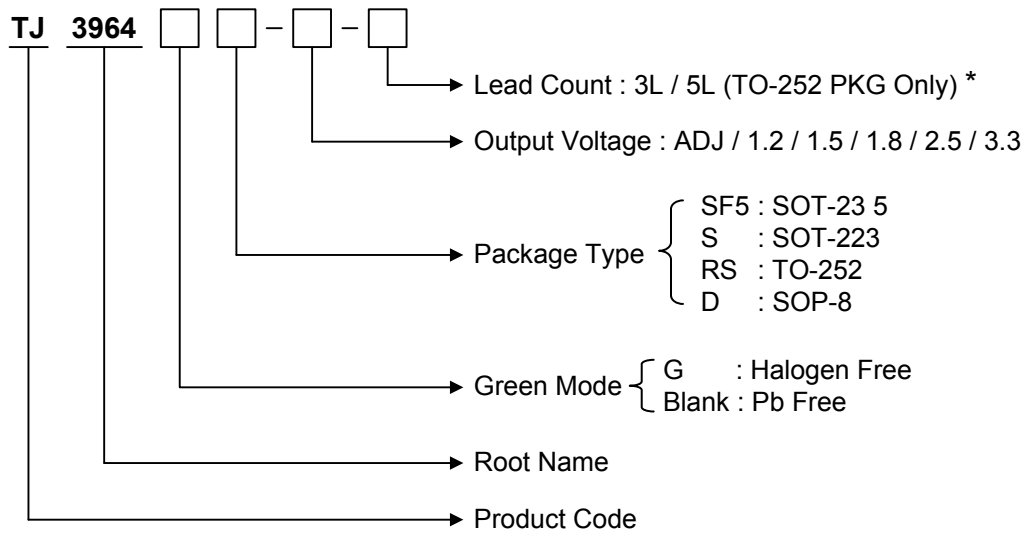

\* It is written to distinguish the lead count of TO-252 PKG

## PIN CONFIGURATION

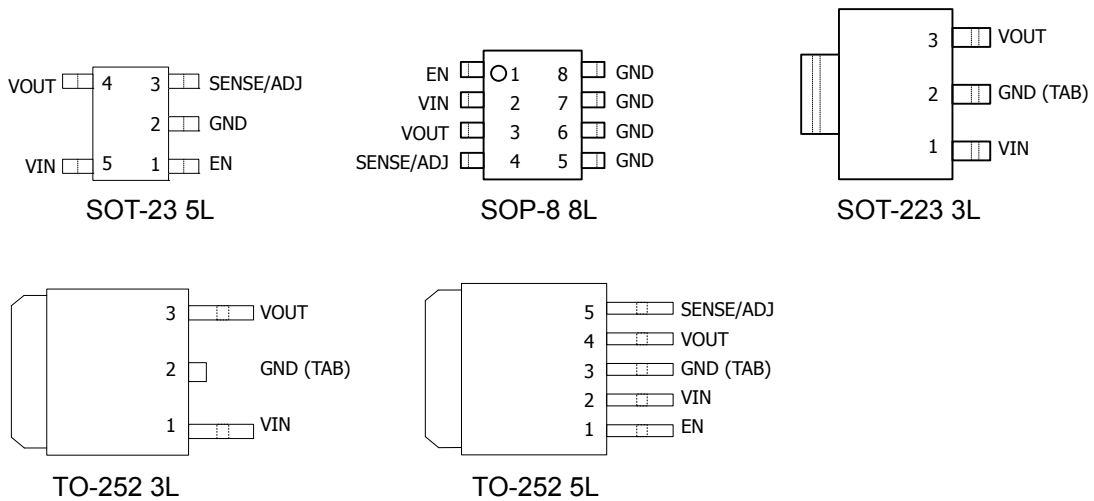

## PIN DESCRIPTION

Pin No.	SOT-223 / TO-252 3 LEAD		SOP-8 8 LEAD	
	Name	Function	Name	Function
1	V <sub>IN</sub>	Input Supply	EN	Chip Enable
2	GND	Ground	V <sub>IN</sub>	Input Supply
3	V <sub>OUT</sub>	Output Voltage	V <sub>OUT</sub>	Output Voltage
4	-	-	SENSE/ADJ	Remote Sense or Output Adjust
5/ 6/ 7/ 8	-	-	GND	Ground

Pin No.	SOT-23 5 LEAD		TO-252 5 LEAD	
	Name	Function	Name	Function
1	EN	Chip Enable	EN	Chip Enable
2	GND	Ground	V <sub>IN</sub>	Input Supply
3	SENSE/ADJ	Remote Sense or Output Adjust	GND	Ground
4	V <sub>OUT</sub>	Output Voltage	V <sub>OUT</sub>	Output Voltage
5	V <sub>IN</sub>	Input Supply	SENSE/ADJ	Remote Sense or Output Adjust

## TYPICAL APPLICATION

Typical 3 Pin Application

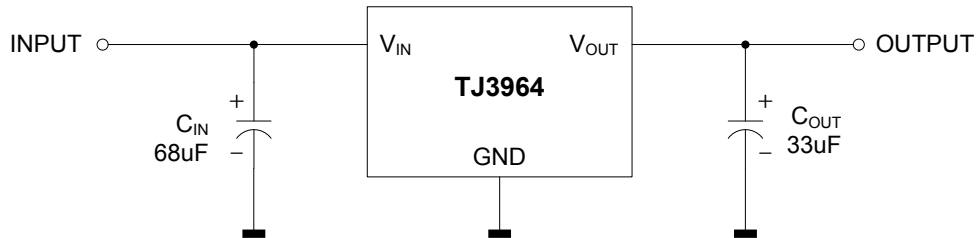

Typical 5 / 8 Pin Application

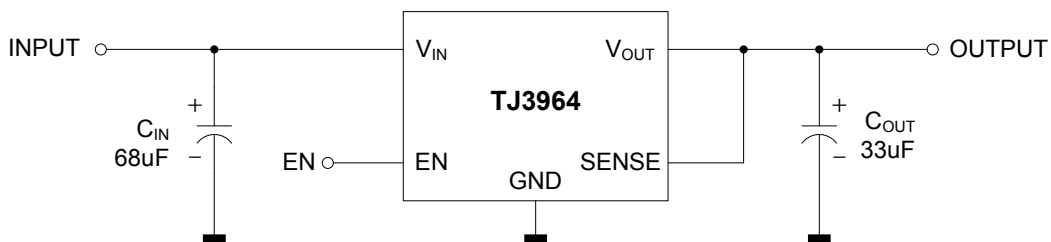

5 / 8 Pin Remote Load Sense Application

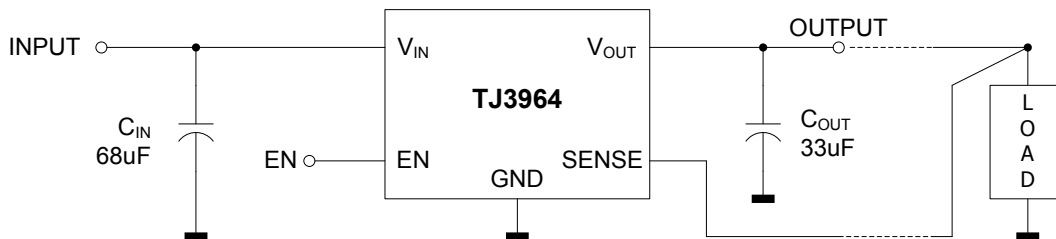

Typical Adjustable Version Application

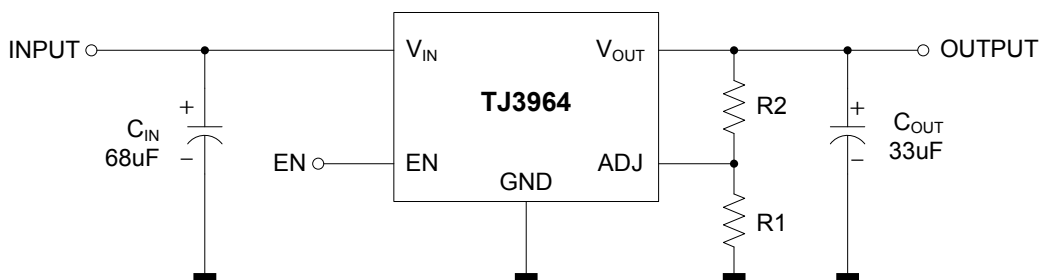

\* TJ3964 can deliver a continuous current of 1A over the full operating temperature. However, the output current is limited by the restriction of power dissipation which differs from packages. A heat sink may be required depending on the maximum power dissipation and maximum ambient temperature of application. With respect to the applied package, the maximum output current of 1A may be still undeliverable.

\* When a Pull-Up resistor is connected between  $V_{EN}$  terminal and  $V_{EN}$  Signal (or  $V_{IN}$  line), the resistance of the Pull-Up resistor should be kept under 10k $\Omega$ .

\* See Application Information.

## ELECTRICAL CHARACTERISTICS<sup>(Note 1)</sup>

Limits in standard typeface are for  $T_J=25^\circ\text{C}$ , and limits in boldface type apply over the full operating temperature range. Unless otherwise specified:  $V_{IN}^{(Note 2)} = V_{O(NOM)} + 1\text{ V}$ ,  $I_L = 10\text{ mA}$ ,  $C_{IN} = 68\text{ uF}$ ,  $C_{OUT} = 33\text{ uF}$ ,  $V_{EN} = V_{IN} - 0.3\text{ V}$

PARAMETER	SYMBOL	TEST CONDITION	MIN.	TYP.	MAX.	UNIT	
Output Voltage Tolerance	$V_O$	$10\text{ mA} < I_L < 1\text{ A}$ $V_{OUT}+1\text{ V} < V_{IN} < 6\text{ V}$	-2 <b>-3</b>	0	2 <b>3</b>	%	
Adjustable Pin Voltage (ADJ version)	$V_{ADJ}$	$10\text{ mA} < I_L < 1\text{ A}$ $V_{OUT}+1.5\text{ V} < V_{IN} < 6\text{ V}$	1.117 <b>1.110</b>	1.145	1.174 <b>1.188</b>	V	
Line Regulation <sup>(Note 3)</sup>	$\Delta V_{LINE}$	$V_{OUT}+1\text{ V} < V_{IN} < 6\text{ V}$	-	0.10	0.22 <b>0.25</b>	%/V	
Load Regulation <sup>(Note 3, 4)</sup>	$\Delta V_{LOAD}$	$10\text{ mA} < I_L < 1\text{ A}$	-	0.25	0.55 <b>0.60</b>	%	
Dropout Voltage	$V_{DROP}$	$I_L = 1\text{ A}$	-	350	450 <b>550</b>	mV	
Ground Pin Current <sup>(Note 6)</sup>	$I_{GND1}$	$I_L = 100\text{ mA}$	-	50	80 <b>100</b>	uA	
		$I_L = 1\text{ A}$	-	50	80 <b>100</b>		
Ground Pin Current <sup>(Note 7)</sup>	$I_{GND2}$	$V_{EN} < 0.2\text{ V}$	-	50	80 <b>100</b>	uA	
Output Peak Current	$I_{PEAK}$		1.4 <b>1.2</b>	1.6	-	A	
Thermal Shutdown Temperature	$T_{SD}$		-	165	-	$^\circ\text{C}$	
Thermal Shutdown Hysteresis	$\Delta T_{SD}$		-	10	-	$^\circ\text{C}$	
Enable threshold	Logic Low	$V_{IL}$	Output = Low	-	0	$0.3 * V_{IN}$	V
	Logic High	$V_{IH}$	Output = High	$0.7 * V_{IN}$	$V_{IN}$	-	V
Enable Input Current	$I_{EN}$	$V_{EN} = V_{IN}$	-	0.05	2	uA	

Note 1. Stresses listed as the absolute maximum ratings may cause permanent damage to the device. These are for stress ratings. Functional operating of the device at these or any other conditions beyond those indicated in the operational sections of the specifications is not implied. Exposure to absolute maximum rating conditions for extended periods may remain possibly to affect device reliability.

Note 2. The minimum operating value for input voltage is equal to either  $(V_{OUT,NOM} + V_{DROP})$  or 2.5V, whichever is greater.

Note 3. Output voltage line regulation is defined as the change in output voltage from the nominal value due to change in the input line voltage. Output voltage load regulation is defined as the change in output voltage from the nominal value due to change in load current.

Note 4. Regulation is measured at constant junction temperature by using a 20ms current pulse. Devices are tested for load regulation in the load range from 10mA to 1A.

Note 5. Dropout voltage is defined as the minimum input to output differential voltage at which the output drops 2% below the nominal value. Dropout voltage specification applies only to output voltages of 2.5V and above. For output voltages below 2.5V, the dropout voltage is nothing but the input to output differential, since the minimum input voltage is 2.5V.

Note 6. Ground current, or quiescent current, is the difference between input and output currents. It's defined by  $I_{GND1} = I_{IN} - I_{OUT}$  under the given loading condition. The total current drawn from the supply is the sum of the load current plus the ground pin current.

Note 7. Ground current, or standby current, is the input current drawn by a regulator when the output voltage is disabled by an enable signal.

## TYPICAL APPLICATION CHARACTERISTIC

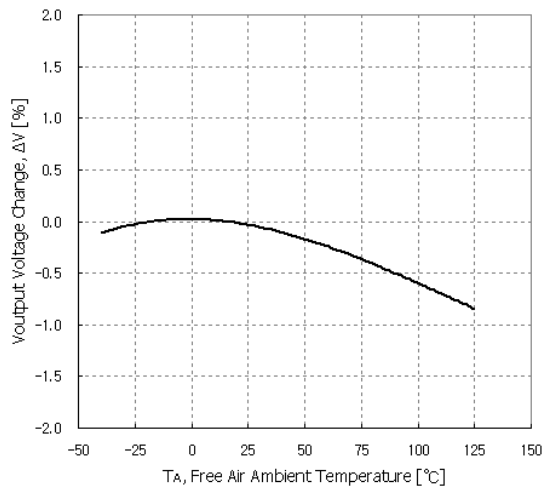

Ambient Temperature vs. Output Voltage Change

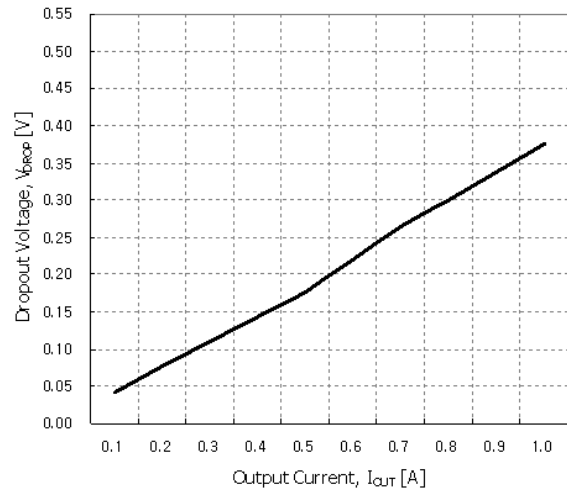

Output Current vs. Dropout Voltage

## APPLICATION INFORMATION

### Output Adjustment (Adjustable Version)

An adjustable output device has output voltage range of 1.145V to 5.0V. To obtain a desired output voltage, the following equation can be used with R1 resistor. The sum of R1 and R2 should be in range of 1kΩ to 100kΩ.

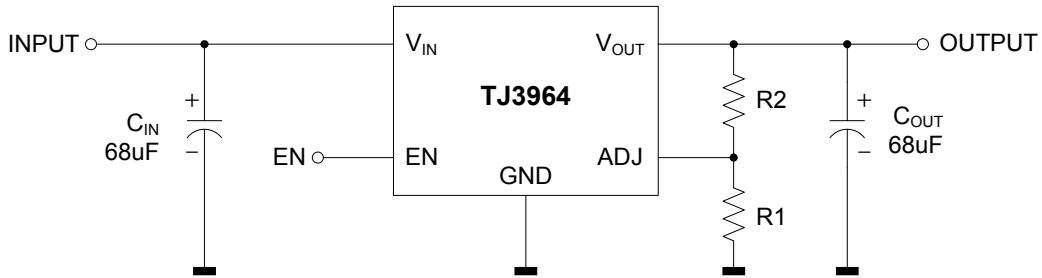

$$R2 = R1 \left( \frac{V_{OUT}}{1.145} - 1 \right)$$

To enhance output stability, a capacitor of 68pF to 100pF can be placed in series with V<sub>OUT</sub> and ADJ.

### SENSE Pin

In applications where the regulator output is not very close to the load, the TJ3964 can provide better remote load regulation characteristics using the SENSE pin. TJ3964 regulates the voltage at the output pin. Hence, the voltage at the remote load will be lower than the voltage at the output pin as a value of the voltage drop across the trace series resistance. If the sense option pin is not required, the sense pin must be connected to the V<sub>OUT</sub> pin. Connecting the sense pin to the remote load will provide regulation at the remote load because the TJ3964 regulates the voltage at the sense pin when the sense option pin is used.

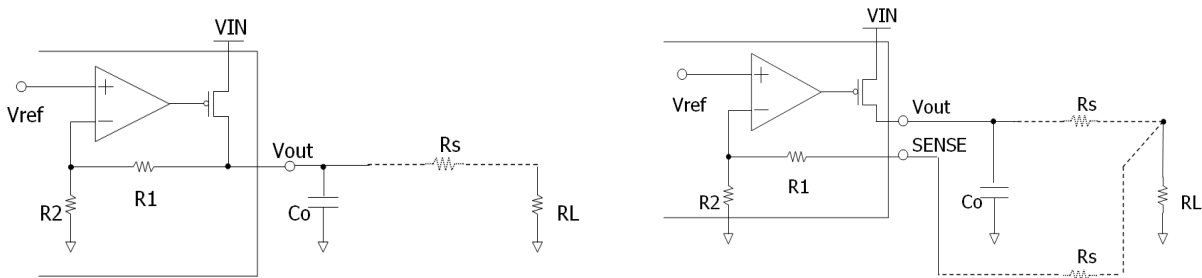



## Output Capacitor

The TJ3964 requires a proper output capacitance to maintain stability and improve transient response over current. The ESR of the output capacitor within the limits of 0.5Ω to 10Ω is required. A minimum capacitance value of 22μF of tantalum or aluminum electrolytic capacitor is recommended. In a case of ceramic capacitor, a minimum capacitance value of 10μF is required and additional resistance of minimum 1Ω should be added with the output capacitor in series to maintain its minimum ESR. The resistance and capacitance have to be varied upon the load current.

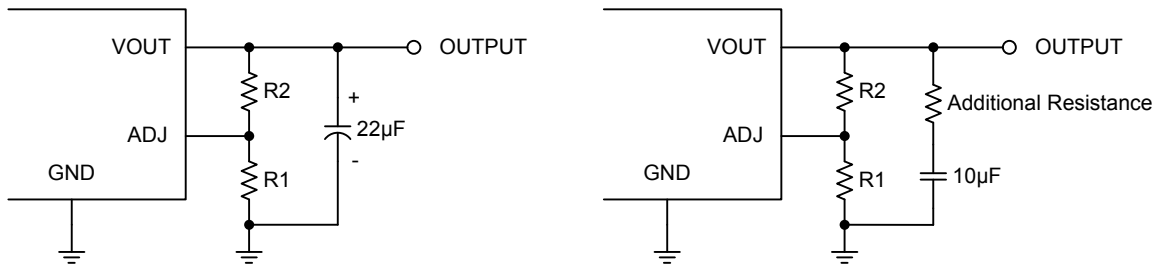

## Maximum Output Current Capability

The TJ3964 can deliver a continuous current of 1A over the full operating junction temperature range. However, the output current is limited by the restriction of power dissipation which differs from packages. A heat sink may be required depending on the maximum power dissipation and maximum ambient temperature of application. With respect to the applied package, the maximum output current of 1A may be still undeliverable due to the restriction of the power dissipation of TJ3964. Under all possible conditions, the junction temperature must be within the range specified under operating conditions. The temperatures over the device are given by:

$$T_C = T_A + P_D \times \theta_{CA} \quad / \quad T_J = T_C + P_D \times \theta_{JC} \quad / \quad T_J = T_A + P_D \times \theta_{JA}$$

where  $T_J$  is the junction temperature,  $T_C$  is the case temperature,  $T_A$  is the ambient temperature,  $P_D$  is the total power dissipation of the device,  $\theta_{CA}$  is the thermal resistance of case-to-ambient,  $\theta_{JC}$  is the thermal resistance of junction-to-case, and  $\theta_{JA}$  is the thermal resistance of junction to ambient.

The total power dissipation of the device is given by:

$$P_D = P_{IN} - P_{OUT} = (V_{IN} \times I_{IN}) - (V_{OUT} \times I_{OUT}) \\ = (V_{IN} \times (I_{OUT} + I_{GND})) - (V_{OUT} \times I_{OUT}) = (V_{IN} - V_{OUT}) \times I_{OUT} + V_{IN} \times I_{GND}$$

where  $I_{GND}$  is the operating ground current of the device which is specified at the Electrical Characteristics. The maximum allowable temperature rise ( $T_{Rmax}$ ) depends on the maximum ambient temperature ( $T_{Amax}$ ) of the application, and the maximum allowable junction temperature ( $T_{Jmax}$ ):

$$T_{Rmax} = T_{Jmax} - T_{Amax}$$

The maximum allowable value for junction-to-ambient thermal resistance,  $\theta_{JA}$ , can be calculated using the formula:

$$\theta_{JA} = T_{Rmax} / P_D = (T_{Jmax} - T_{Amax}) / P_D$$

TJ3964 is available in SOT23-5, SOT-223, TO-252 and SOP-8 packages. The thermal resistance depends on amount of copper area or heat sink, and on air flow. If the maximum allowable value of  $\theta_{JA}$  calculated above is as described in Table 1, no heat sink is needed since the package can dissipate enough heat to satisfy these requirements. If the value for allowable  $\theta_{JA}$  falls near or below these limits, a heat sink or proper area of copper plane is required.

Table. 1. Absolute Maximum Ratings of Thermal Resistance  
No heat sink / No air flow / No adjacent heat source /  $T_A = 25^\circ\text{C}$

Characteristic	Symbol	Rating	Unit
Thermal Resistance Junction-To-Ambient / SOT23-5	$\theta_{JA-SOT23-5}$	265	$^\circ\text{C/W}$
Thermal Resistance Junction-To-Ambient / SOP-8	$\theta_{JA-SOP-8}$	165	$^\circ\text{C/W}$
Thermal Resistance Junction-To-Ambient / SOT223	$\theta_{JA-SOT223}$	140	$^\circ\text{C/W}$
Thermal Resistance Junction-To-Ambient / TO252	$\theta_{JA-TO252}$	105	$^\circ\text{C/W}$

In case that there is no cooling solution and no heat sink / minimum copper plane area for heat sink, the maximum allowable power dissipation of each package is as follow;

Characteristic	Symbol	Rating	Unit
Maximum Allowable Power Dissipation at $T_A=25^\circ\text{C}$ / SOT23-5	$P_{DMax-SOT23-5}$	0.378	W
Maximum Allowable Power Dissipation at $T_A=25^\circ\text{C}$ / SOP-8	$P_{DMax-SOP-8}$	0.606	W
Maximum Allowable Power Dissipation at $T_A=25^\circ\text{C}$ / SOT223	$P_{DMax-SOT223}$	0.714	W
Maximum Allowable Power Dissipation at $T_A=25^\circ\text{C}$ / TO252	$P_{DMax-TO252}$	0.952	W

- Please note that above maximum allowable power dissipation is based on the minimum copper plane area which does not exceed the proper footprint of the package. And the ambient temperature is  $25^\circ\text{C}$ .

If proper cooling solution such as heat sink, copper plane area, air flow is applied, the maximum allowable power dissipation could be increased. However, if the ambient temperature is increased, the allowable power dissipation would be decreased.

For example, in case of SOT-223 and TO-252 package,  $\theta_{JA-SOT223}$  is  $140^\circ\text{C/W}$  and  $\theta_{JA-TO252}$  is  $105^\circ\text{C/W}$ , however, as shown in below graph,  $\theta_{JA}$  could be decreased with respect to the copper plane area. So, the specification of maximum power dissipation for an application is fixed, the proper copper plane area could be estimated by following graphs. As shown in graph, wider copper plane area leads lower  $\theta_{JA}$ .

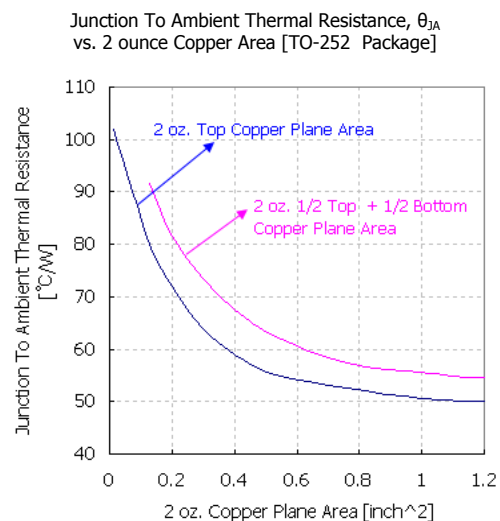
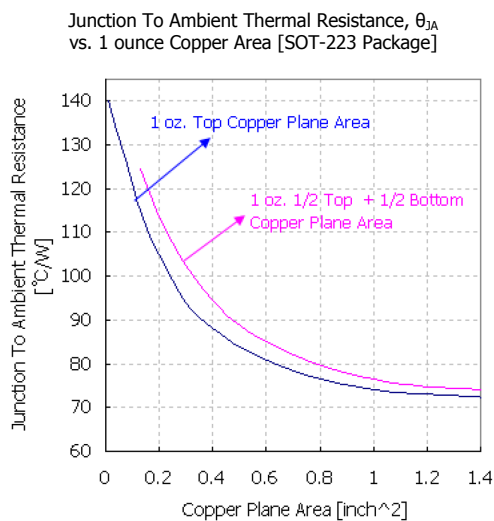

The maximum allowable power dissipation is also influenced by the ambient temperature. With the above  $\theta_{JA}$ -Copper plane area relationship, the maximum allowable power dissipation could be evaluated with respect to the ambient temperature. As shown in graph, the higher copper plane area leads  $\theta_{JA}$ . And the higher ambient temperature leads lower maximum allowable power dissipation.

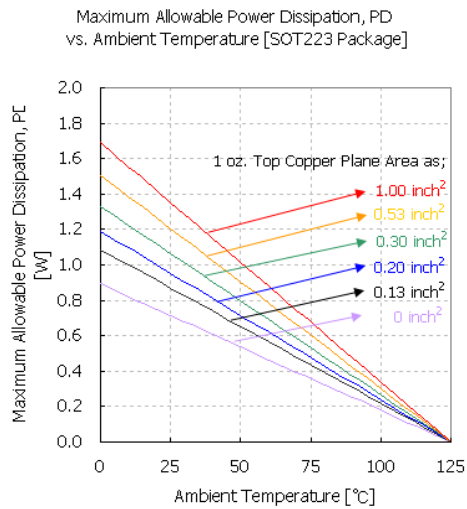

All this relationship is based on the aforesaid equation ;  $\theta_{JA} = T_{Rmax} / P_D = (T_{Jmax} - T_{Amax}) / P_D$

T.B.D